

JLBIOS609

Built-in oven

User information



John Lewis

Important safety information



It is most important that this instruction manual should be retained with the appliance for future reference. Should the appliance be sold or transferred to another owner, or should you move house and leave the appliance, always ensure that the book is supplied with the appliance in order that the new owner can get to know the functioning of the appliance and the relevant warnings. These warnings have been provided in the interest of safety. You **MUST** read them carefully before use or installation by a qualified person. If you are unsure of the meanings of these warnings contact the John Lewis branch from which you purchased the appliance.

Electrical safety

- This appliance must be only connected by a **registered electrician**.
- In the event of a fault or damage to the appliance: Take the fuses out or switch off.
- **Repairs** to the appliance must only be carried out by **qualified service engineers**. Considerable danger may result from improper repairs. If repairs become necessary, please contact our Customer Services or your dealer.

Child safety

- This oven is designed to be operated by adults. Do not allow children to play with or near the oven.
- Never leave children unsupervised when the appliance is in use.

Safety whilst using

- People (including children) who, because of their physical, sensory or mental capabilities or their inexperience or ignorance are not able to use the device safely, should not use this device without supervision or instruction by a responsible person.
- This appliance is intended to be used for cooking, roasting and baking food in the home.
- Take care when connecting electric appliances to sockets nearby. Do **not** allow connecting leads to come into contact with or to catch beneath the hot oven door.
- **Warning: Risk of burns!** The interior of the oven becomes hot during use.
- Using ingredients containing alcohol in the oven may create an alcohol-air mixture that is easily ignited. In this case, open the door carefully. Do not have embers, sparks or naked flames in the vicinity when opening the door.



Information on acrylamides

According to the latest scientific knowledge, intensive browning of food, especially in products containing starch, can constitute a health risk due to acrylamides. Therefore we recommend cooking at the lowest possible temperatures and not browning foods too much.

How to avoid damage to the appliance

- Do not line the oven with aluminium foil and do not place baking trays, pots, etc. on the oven floor, as the heat that builds up will damage the oven enamel.
- Fruit juices dripping from the baking tray will leave permanent stains. For very moist cakes, use a deep tray.
- Do not put any strain on the oven door when open.
- Never pour water directly into the oven when it is hot. This could cause damage to or discolouration of the enamel.
- Rough handling, especially around the edges of the front panel, can cause the glass to break.
- Do not store flammable materials inside the oven. These could ignite when the oven is switched on.
- Do not store moist foods inside the oven. This could damage the oven enamel.
- After switching off the cooling fan, do not keep uncovered dishes in the oven. Moisture may condense in the oven interior or on the glass doors and may get into the units.



Note on enamel coating

Changes in the colour of the oven's enamel coating as a result of use do not affect the appliance's suitability for normal and correct use. They therefore do not constitute a defect in the sense of the warranty law.

Disposal



Packaging material

The packaging materials are environmentally friendly and can be recycled. The plastic components are identified by markings, e.g. >PE<, >PS<, etc. Please dispose of the packaging materials in the appropriate container at the community waste disposal facilities.



Old appliance

The symbol  on the product or on its packaging indicates that this product may not be treated as household waste. Instead it should be taken to the appropriate collection point for the recycling of electrical and electronic equipment. By ensuring this product is disposed of correctly, you will help prevent potential negative consequences for the environment and human health, which could otherwise be caused by inappropriate waste handling of this product. For more detailed information about recycling of this product, please contact your local council, your household waste disposal service or the shop where you purchased the product.



Warning: Before disposing of old appliances, please make them inoperable so they cannot be a source of danger. **To do this, disconnect the appliance from the mains supply and remove the mains cable from the appliance.**

Contents

For the User

Important safety information	2
Disposal	4
Description of the appliance	6
General overview	6
Control panel	6
Oven features	7
Oven accessories	7
Grill set	7
Before using for the first time	8
Setting the time	8
Initial cleaning	8
Using the oven	9
The electronic oven control	9
Fast heat up	12
Oven functions	12
Inserting the oven shelf and roasting pan	13
Grill set	14
Clock functions	15
Other functions	22
Switching off the display	22
Child safety device	22
Button lock	23
Heat+Hold	23
Uses, tables and tips	24
Baking	24
Baking table	26
Table: Desserts	29
Bakes and gratins table	30
Frozen ready meals table	31
Roasting	32
Table: Meat, roasting, casseroles	33
Table: Roasting, casseroles, au gratin	34
Low temperature cooking	35
Table: Low temperature cooking	35
Grill sizes	36
Grilling table	36



Defrosting	37
Defrosting table	37
Drying	38
Keep warm	39
Making preserves	40
Cleaning and care	41
Outside of the appliance	41
Oven interior	41
Accessories	41
Pyrolytic cleaning	42
Oven shelf runner	43
Cleaning the oven shelf runner	44
Oven lighting	45
Oven door	46
Oven door glass	48
What to do if	51

For the Installer

Electrical connection	53
Installation instructions	54
Safety information for the installer	54
Repairs - after sales service	59
Spare parts	59

Guide to use the Instruction Manual

The following symbols will be found in the text to guide you throughout the Instructions:

-  Safety Instructions
-  Hints and Tips
-  Environmental Information

Description of the appliance

General overview

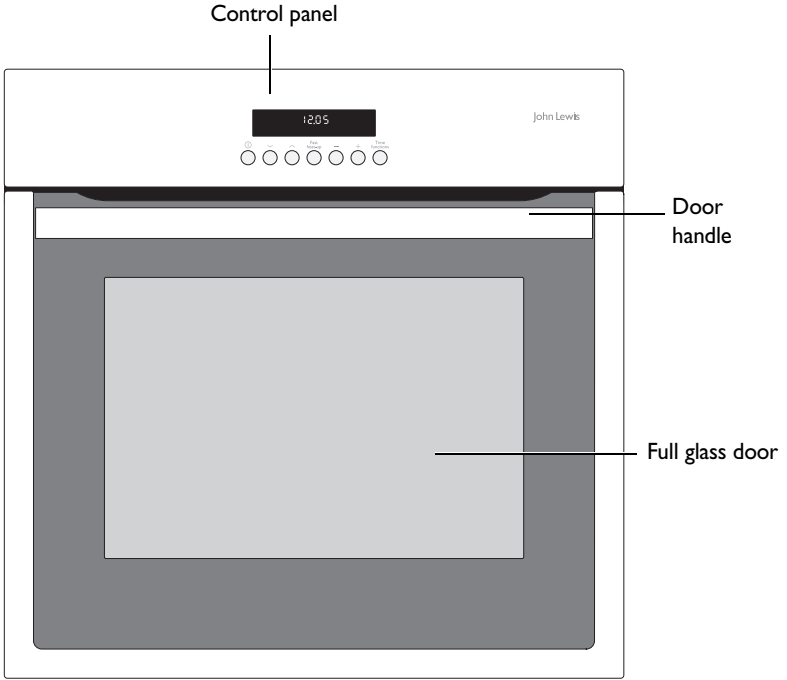

Control panel

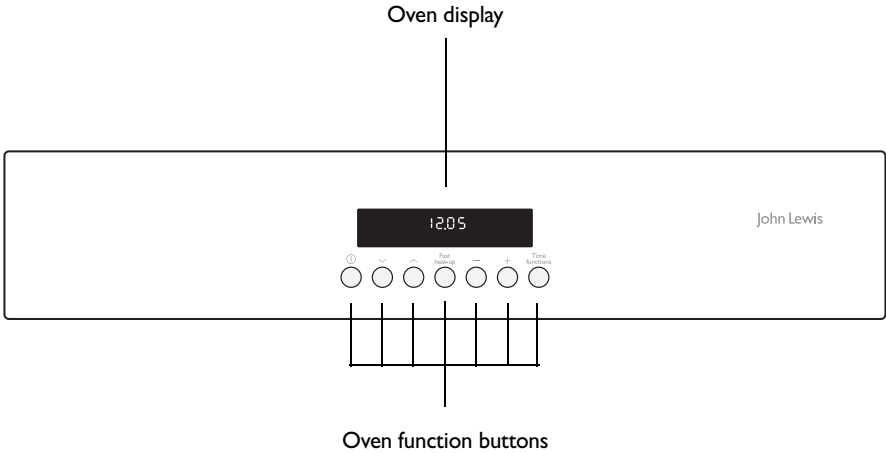

Oven features

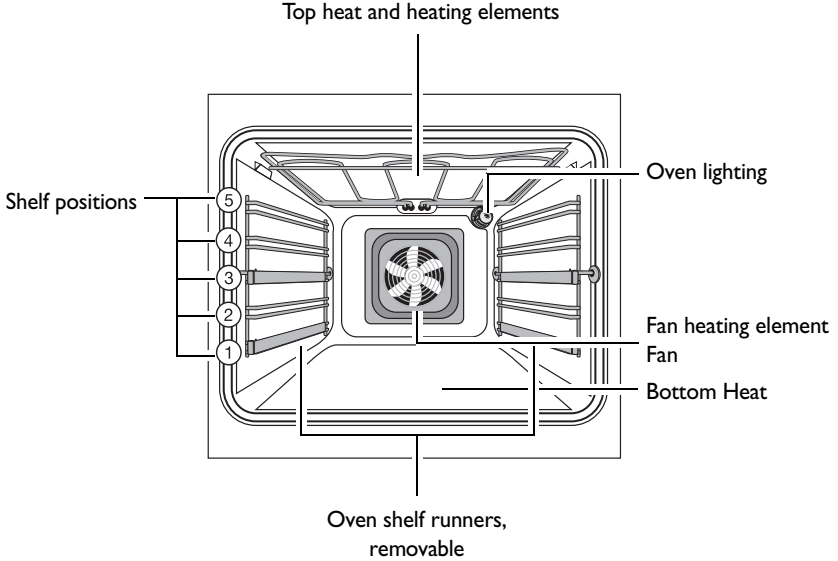

Oven accessories

Oven shelf

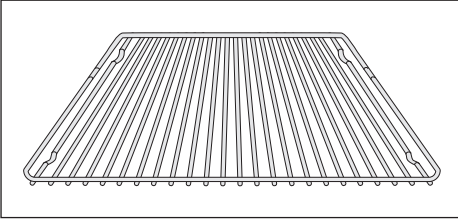

For dishes, cake tins and items for roasting and grilling.

Grill set

Grill

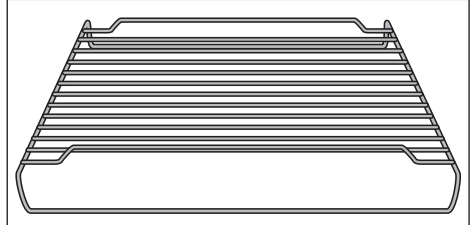

Roasting pan shelf for roasting and grilling.

Roasting pan

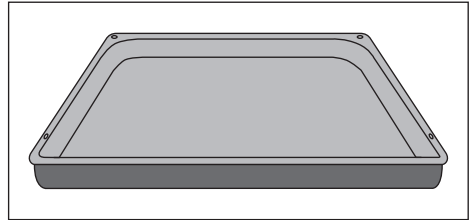

For baking and roasting or for collecting fat.



Before using for the first time

Setting the time

i The oven only operates when the time has been set.

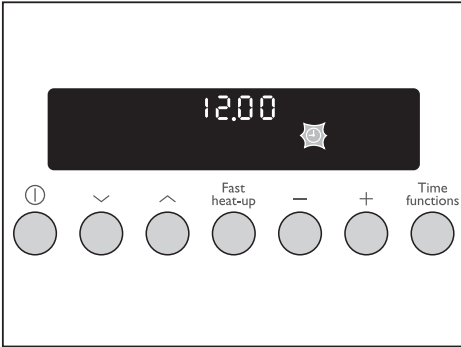
When the appliance is connected to the electrical supply or when there has been a power cut, Time  flashes automatically.



Using the  or  button, set the current time.

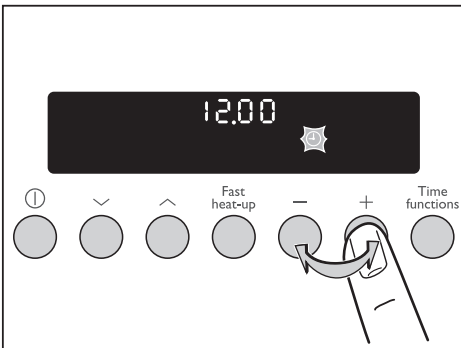

After approx. 5 seconds, the clock stops flashing and the clock displays the time of day set.

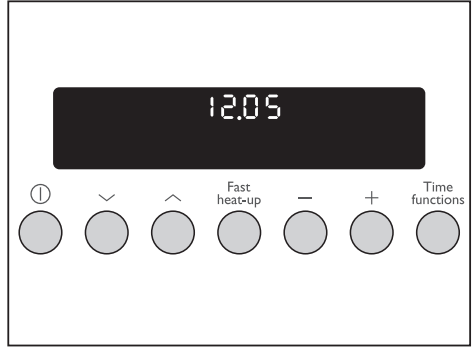

The appliance is now ready to use.

Initial cleaning

Clean the oven before using it for the first time.

! **Important:** Do not use caustic or abrasive cleaning agents! These can damage the oven surfaces.

i For the metal surfaces, use commercially available cleaning agents.



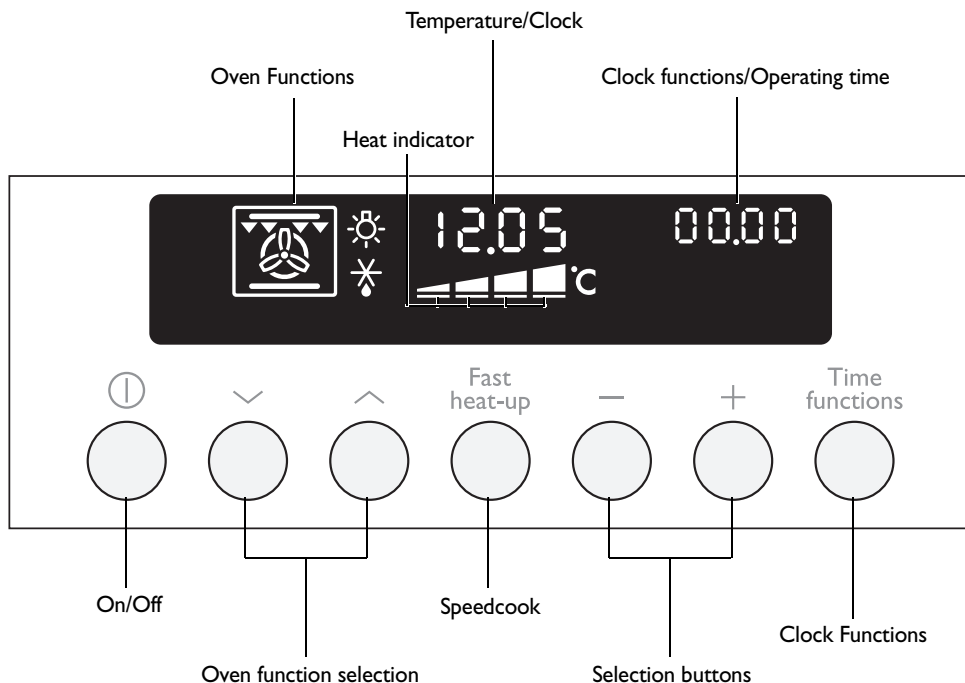

1. Open the oven door:
The oven light illuminates.
2. Remove all accessories and the shelf support rails and clean with warm water and washing-up liquid.
3. Wash the oven in the same way, and wipe dry.
4. Wipe the front of the appliance with a damp cloth.

Using the oven



The electronic oven control



i General instructions

- Always switch the appliance on first by pressing the On/Off button.
- When the selected function light illuminates, the oven begins to heat up or the time set begins to count down.
- The Operating time display shows how long the oven has been operating. This display can only be seen if none of the clock functions Minute timer , Cooking duration  or End of cooking  are set.
- The oven light switches on as soon as an oven function is selected.
- When the selected temperature is reached, an audible signal sounds.
- Switch off the oven using the On/Off  button.

Selecting an oven function

1. Switch on the appliance using the On/Off  button.
2. Press the  or  button repeatedly until the desired oven function appears.

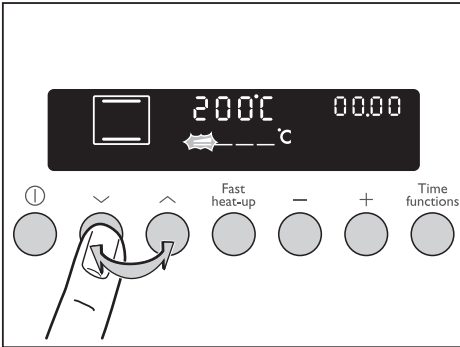

- A suggested temperature appears in the temperature display.
- If the suggested temperature is not changed within approx. 5 seconds, the oven starts to heat up.

 The oven function can be changed while the oven is working.

Changing the oven temperature

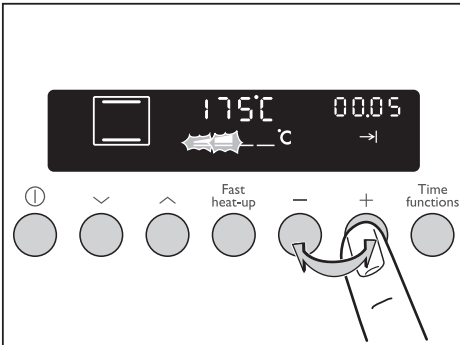



Press the  or  button to raise or lower the temperature.

The setting changes in steps of 5°C.

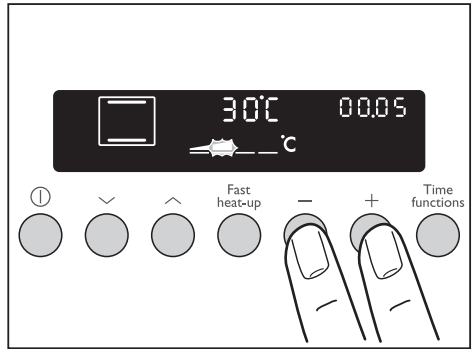
Checking the temperature





Press the  and  buttons at the same time. The current oven temperature appears in the temperature display.

 The temperature check does not work with oven functions with suggested temperatures that cannot be adjusted, such as e. g., Low temperature cooking.

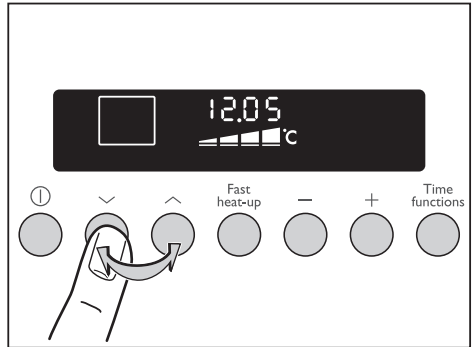
Switching off the oven function



To switch off the oven, press the  or  button repeatedly until no oven function is displayed.

Switching the oven off

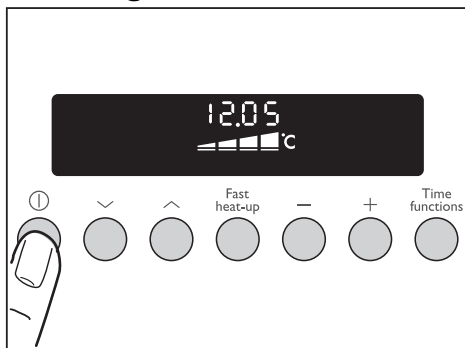

Switch off the appliance using the On/Off  button.

Cooling fan

The fan switches on automatically in order to keep the appliance's surfaces cool. When the oven is switched off, the fan continues to run to cool the appliance down, then switches itself off automatically.

Heat indicator

Warming up indicator

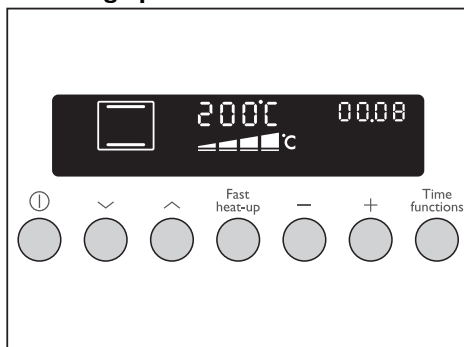

When the oven function has been **switched on** the bars that slowly light up one after the other indicate how far the oven has heated up.

Residual heat indicator

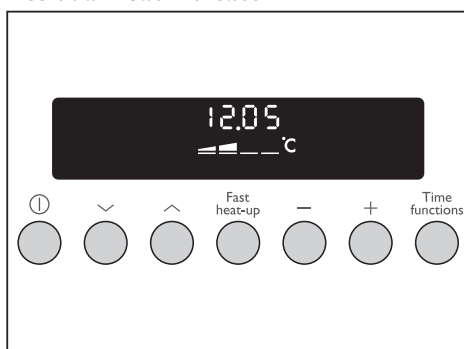

When the oven has been **switched off**, the bars that are still lit indicate the residual heat remaining in the oven.

Fast heat up

After an oven function is selected, the Fast heat up °C➡ function can be used to pre-heat the empty oven in a relatively short time.



Important: Do not put the food to be cooked into the oven, **until Fast heat up is completed** and the oven is operating using the desired function.

1. Set the desired oven function (e. g. Conventional). If necessary, change the suggested temperature.
2. Press the Fast heat up button.

The bars flashing one after another show that Fast heat up is operating.

When the temperature set is reached, the bars of the heat indicator light up. An audible signal sounds.

The oven now continues heating according to the pre-set oven function and temperature. You can now place the food in the oven.



The Fast heat up function can be switched on with the oven functions Convection with ring heating element , Pizza setting , Conventional and Rotitherm .

Oven functions

The oven has the following functions:

Oven function	Application
Convection with ring heating element	For baking on up to three oven levels at the same time. Set the oven temperatures 20-40 °C lower than when using Conventional.
Pizza setting	For baking on one oven level dishes that require more intensive browning and a crispy base . Set the oven temperatures 20-40 °C lower than when using Conventional.
Low temperature cooking	For preparing especially tender, succulent roasts.
Conventional	For baking and roasting on one oven level .
Rotitherm	For roasting larger joints of meat or poultry on one level. The function is also suitable for gratinating and browning .
Dual grill	For grilling flat food items in large quantities and for toasting .
Grill	For grilling flat food items placed in the middle of the grill and for toasting .
Keep warm	To keep dishes warm.
Defrost	For defrosting e. g. flans and gateaux, butter, bread, fruit or other frozen foods .
Bottom heat	For baking cakes with crispy or crusty bases .
Pyroluxe	For automatic pyrolytic cleaning of the oven. It burns off residues in the oven, which can then be removed with a cloth when the oven has cooled down. The oven is heated to approximately 500° C.

Inserting the oven shelf and roasting pan

Inserting the roasting pan:

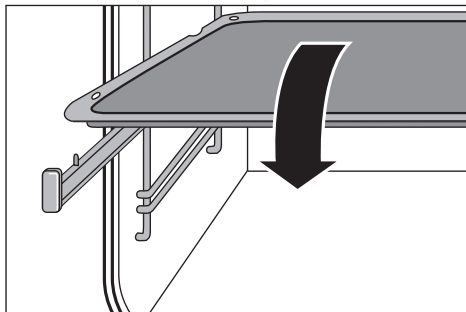

Insert the roasting pan on the telescopic runners of the desired oven level so that the two holes engage on the front retaining pins on the telescopic runners.

Inserting the oven shelf:

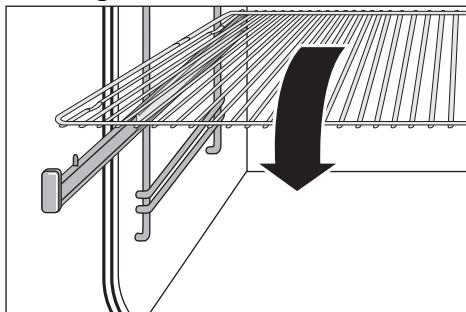

Insert the oven shelf so that the feet point downwards.

Insert the oven shelf on the telescopic runners of the selected oven level.

i The high rim around the oven shelf is an additional device to prevent cookware from slipping.

Inserting the oven shelf and roasting pan together:

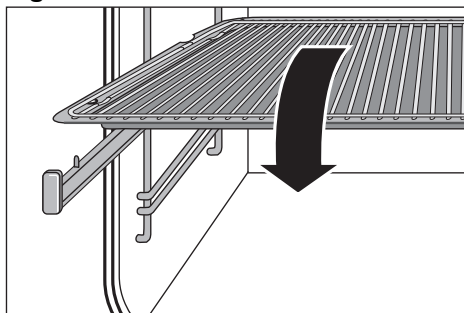

Lay the oven shelf on the roasting pan.

Insert the oven shelf and the roasting pan on the telescopic runners of the selected oven level so that the two holes of the roasting pan engage on the front retaining pins on the telescopic runners.

i To make it easier to insert the insertable component when runners are extended to different extents, lay the insertable component onto the runners at the back, push it in as far as the stop and then lower it onto the retaining pins at the front.

Grill set

The grill set consists of grill and roasting pan. The grill can be used on both sides.



Warning: There is a risk of burning when removing the roasting pan from the hot oven!

Inserting the grill tray underneath:

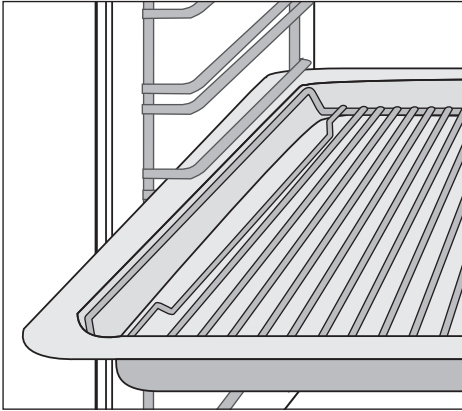

The grill tray rests in the roasting pan.

Push the roasting pan between the guide bars of the selected oven level.



For roasting larger joints of meat or poultry on one oven shelf.

Inserting the grill tray on top:

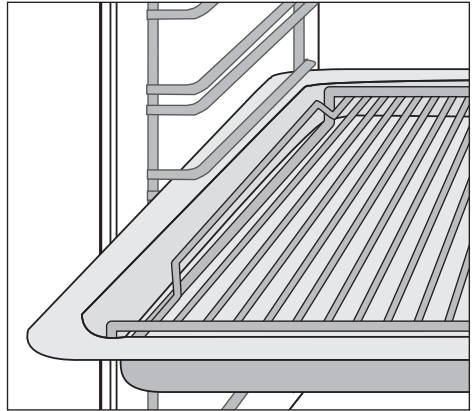

The grill tray rests on the roasting pan.

Push the roasting pan between the guide bars of the selected oven level.



For grilling flat food items in large quantities and for toasting.

Clock functions

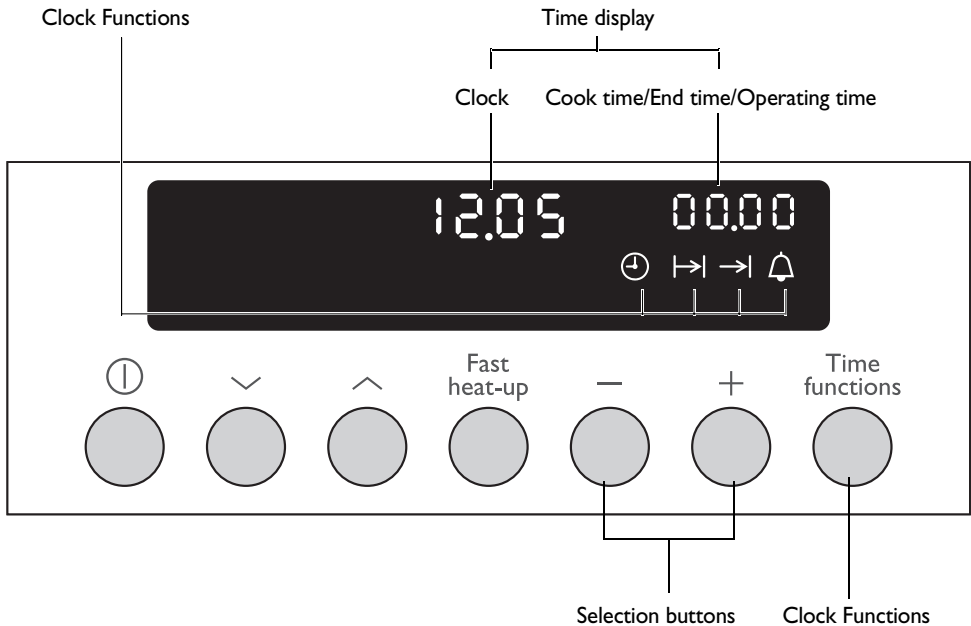

Minute timer

To set a countdown. A signal sounds after the time has elapsed.

This function does not affect the functioning of the oven.

Cooking duration

To set how long the oven is to be in use.

End of cooking

To set when the oven is to switch off again.

Time

To set, change or check the time

(See also section "Before Using for the First Time").



How to use the clock functions

- After a clock function has been selected, the corresponding function light flashes for about 5 seconds. During this period, the desired times can be set or modified using the or button.
- When the desired time has been set, the corresponding function light continues to flash for approx. 5 seconds, then remains illuminated. The set time begins to run.
- With Countdown the oven must also be switched on in order to set the clock function.
- By pressing and at the same time, the time set can be reset.



Checking the time set or remaining

Press the Time functions button repeatedly, until the appropriate clock function flashes and the time set or remaining is displayed.





Using residual heat with the Cooking duration and End of cooking clock functions

When the Cooking duration and End of cooking clock functions are used, the oven switches the heating elements off, when 90% of the time set or calculated has elapsed. The residual heat present is used to continue the cooking process until the time set has elapsed (3 to 20 mins.).

Minute timer 

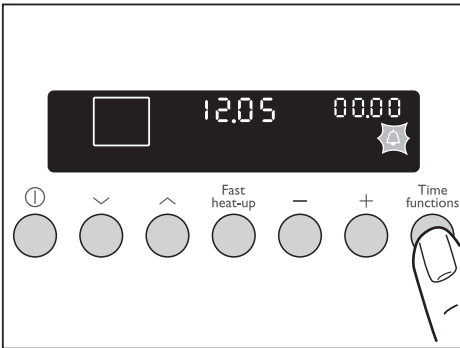
1. Press the Time functions button repeatedly until Minute timer  flashes.



2. Using the  or  button, set the desired countdown.

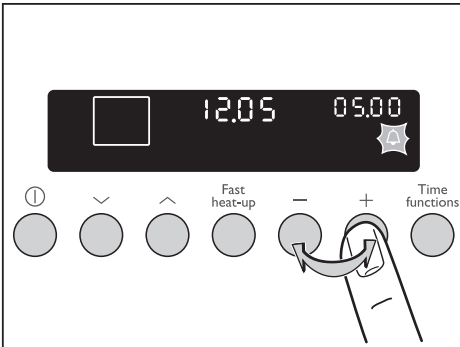

After about 5 seconds, the display shows the time remaining.

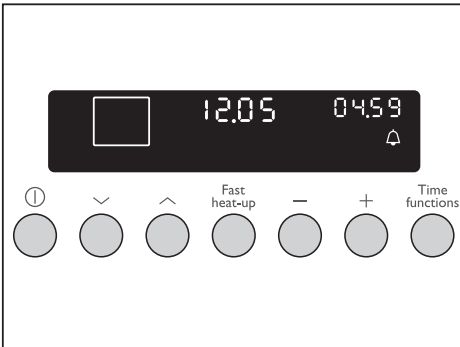

Minute timer  lights up

When 90% of the time set has elapsed, a signal sounds.

When the time has elapsed, a signal sounds for 1 minute.

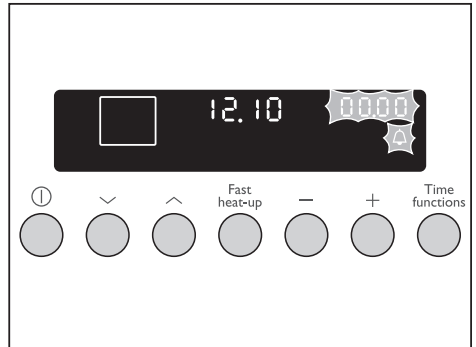



“00.00” and Minute timer  flash.

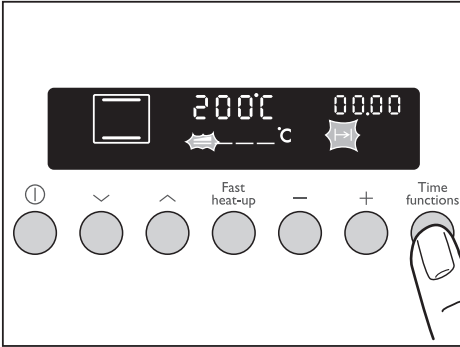

To stop the flashing and the audible signal:
Press any button.

Cooking duration

1. Select oven function and temperature.



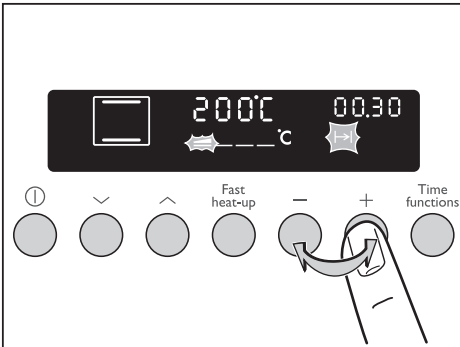

2. Press the Time functions  button repeatedly until Cooking duration  flashes.

3. Using the  or  button, set the desired cooking time.

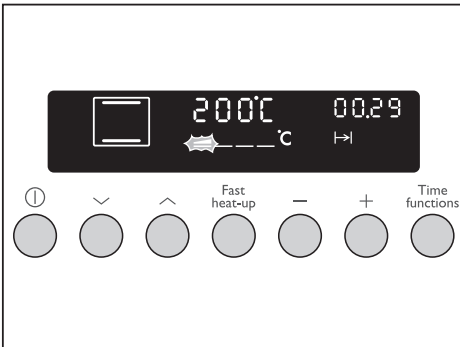

Cooking duration  lights up



When the time has elapsed, "00:00" and Cooking duration  flash.

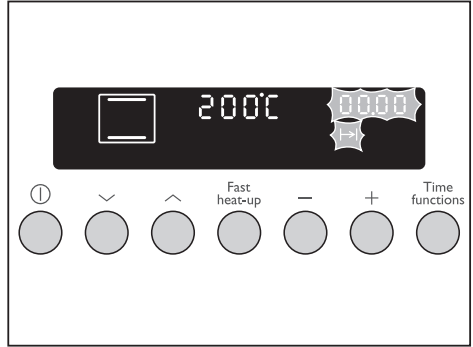



A signal sounds for 2 minutes.
The oven switches itself off.

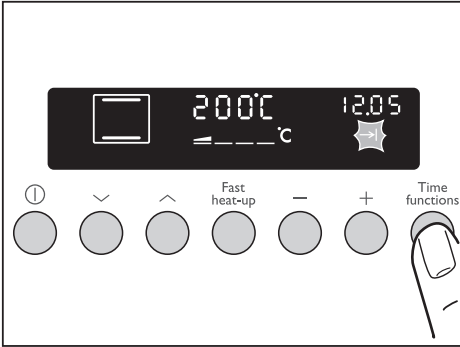

To stop the flashing and the audible signal:
Press any button.

End of cooking 

1. Select oven function and temperature.



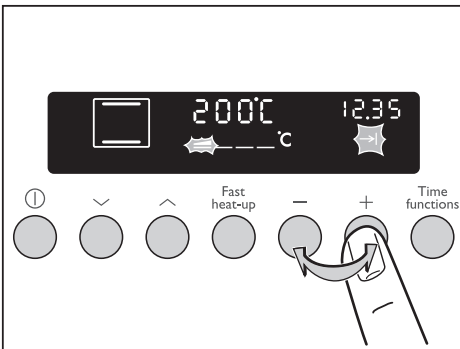

2. Press the Time functions button repeatedly until End of cooking  flashes.

3. Using the  or  button, set the desired switch-off time.

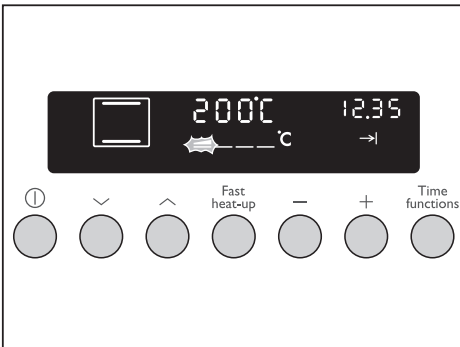

End of cooking  lights up and the switch-off time is displayed.



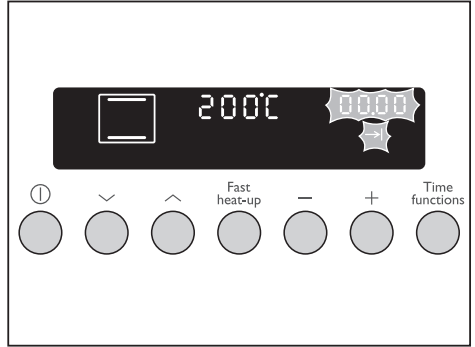

When the time has elapsed, “00.00” and End of cooking  flash.



A signal sounds for 2 minutes.
The oven switches itself off.



To stop the flashing and the audible signal:
Press any button.

Cooking duration and End of cooking combined

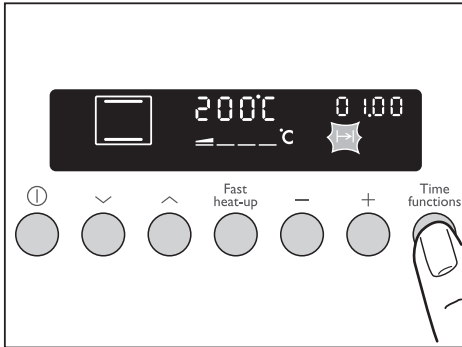

 Cooking duration  and End of cooking  can be used simultaneously, if the oven is to be switched on and off automatically at a **later time**.

1. Select oven function and temperature.

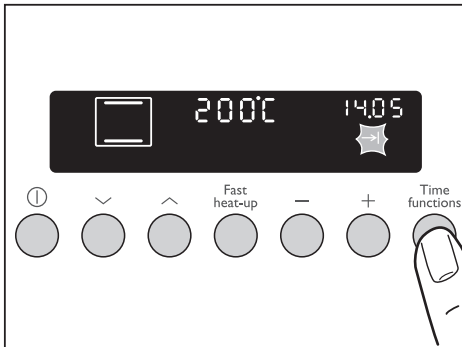

2. Using the Cooking duration  function, set the time required for cooking the dish, e. g.,: 1 hour.
3. Using the End of cooking  function, set the time at which the dish is to be ready, e. g.,: at 14:05.



Cooking duration  and End of cooking  light up.

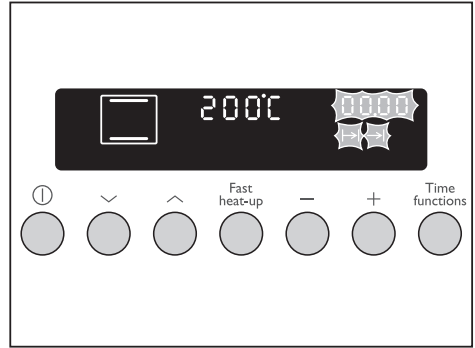



The oven switches itself on automatically at the time calculated.

e. g.,: at 13:05.

When the set Cooking duration has elapsed, a signal sounds for 2 minutes and the oven switches itself off.



e. g.,: at 14:05.

Changing the time

 The time can only be modified, if the child safety device is deactivated, neither of the clock functions Cooking duration  or End of cooking  nor any oven functions are set.

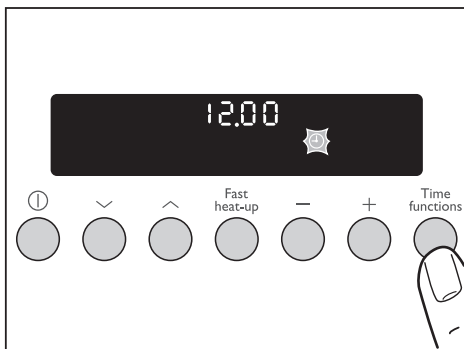
1. Press the Time functions button repeatedly until Time  flashes..



2. Using the  or  button, set the current time.

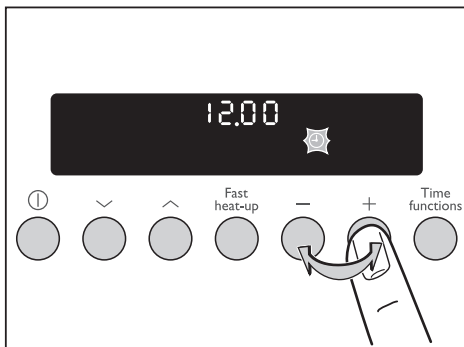

After approx. 5 seconds, the clock stops flashing and the clock displays the time of day set.

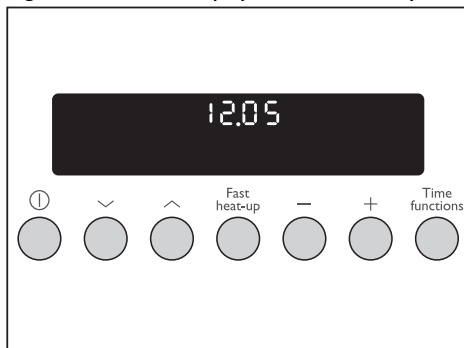

The appliance is now ready to use.



Other functions

Switching off the display



You can save energy by switching off the clock display.

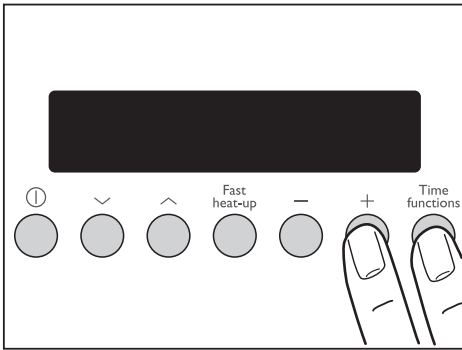

Switching off the clock display

1. If required, switch off the appliance using the On/Off  button.
2. Press the Time functions button and the  button at the same time until the display goes out.



As soon as the oven is switched on again, the display comes on automatically. When the appliance is switched off again, the clock display goes out again. To have the clock display on permanently again, you must set the clock again.

Switching on the clock display

1. If required, **switch off** the appliance using the On/Off  button.
2. Press the Time functions button and the  button at the same time until the display is visible again.

Child safety device

The appliance cannot be switched on when the child safety device is activated.

Activating the child safety device

1. If necessary, **switch on** the appliance using the On/Off  button.

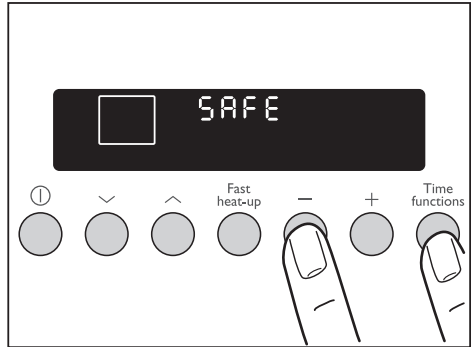

No oven function must be selected.



2. Press and hold the Time functions and  buttons at the same time, until "SAFE" appears in the display.

The child safety device is now set.

Cancelling the child safety device

1. If necessary, switch on the appliance using the On/Off  button.
2. Press and hold the Time functions and  buttons at the same time, until "SAFE" disappears from the display.

The child safety device is now cancelled and the appliance is again ready for use.

Button lock

This function is used to ensure that oven functions set are not accidentally altered.

Activating the button lock

1. If necessary, **switch on** the appliance using the On/Off .

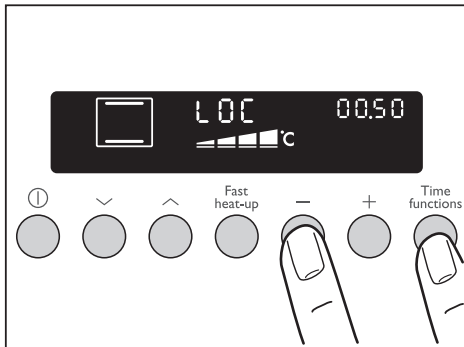

2. Select the oven function.
3. Press and hold the Time functions and  buttons at the same time, until “LOC” appears in the display.

The button lock is now engaged.

Cancelling the button lock

Press and hold the Time functions and  buttons at the same time, until “LOC” disappears from the display.

The button lock is automatically lifted when the oven function is switched off.

Heat+Hold





The Heat+Hold function keeps your prepared dish warm for 30 minutes, after the baking or roasting process is completed.

This is helpful, for example, if your guests are late.

Pre-condition for Heat+Hold:

- Set temperature is above 80°C

Switching on Heat+Hold

1. Set clock functions Cooking duration  and/or End of cooking .
 2. Press the Time functions button repeatedly until the symbol Keep warm  appears in the display.
 3. Press the  button. “00:30:” appears in the display.
 4. As soon as the oven function is completed, a signal sounds and Heat+Hold starts.
- The oven function set runs at 80°C for 30 minutes.
- As soon as the 30 minutes with Heat+Hold has elapsed, the oven switches itself off.



 **Irrespective of an oven function being set, Heat+Hold remains active. You can change between the oven functions.**

Uses, tables and tips



Baking

Oven function: Convection with ring heating element  or **Conventional** 

Baking tins

- For Conventional  dark metal and non-stick tins are suitable.
- For Convection with ring heating element  bright metal tins are also suitable.

Oven levels

- Baking with Conventional  is possible on one oven level.
- With Convection with ring heating element  you can bake on up to 3 baking trays at the same time:

1 baking tray:

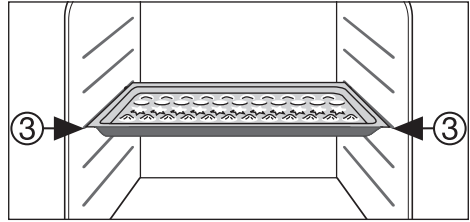

e.g. oven level 3

1 cake tin:

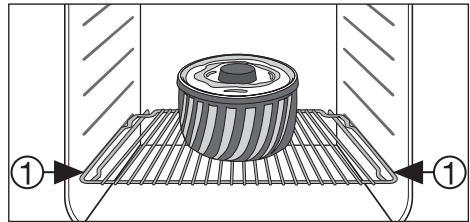

e.g. oven level 1

2 baking trays:

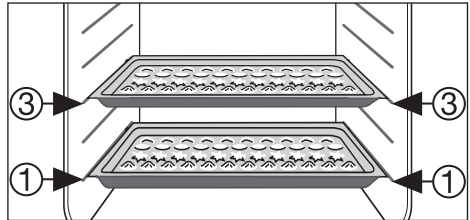

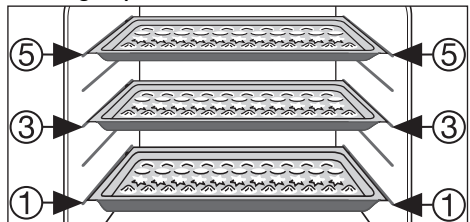

z. g., oven levels 1 and 3

3 baking trays:



oven levels 1, 3 and 5

General instructions

- Insert the tray with the bevel at the front.
- With Conventional  or Convection with ring heating element  you can also bake with two tins next to one another on the oven shelf at the same time. This does not significantly increase baking time.

 When frozen foods are used the trays inserted may distort during cooking. This is due to the large difference in temperature between the freezing temperature and the temperature in the oven. Once the trays have cooled they will return to their normal shape.

How to use the baking tables

The tables give the required temperature settings, baking times and oven shelf levels for a selection of typical dishes.

- Temperatures and baking times are for guidance only, as these will depend on the consistency of pastry, dough or mixture, the amount and the type of baking tin.
- We recommend using the lower temperature the first time and then if necessary, for example, if a deeper browning is required, or baking time is too long, selecting a higher temperature.
- If you cannot find the settings for a particular recipe, look for the one that is most similar.
- If baking cakes on baking trays or in tins on more than one level, baking time may be extended by 10-15 minutes.
- Moist recipes (for example, pizzas, fruit flans, etc.) are baked on one level.
- Cakes and pastries at different heights may brown at an uneven rate at first. If this occurs, **please do not change the temperature setting**. Different rates of browning even out as baking progresses.

- Your new oven may bake or roast differently to your previous appliance. So adapt your normal settings (temperature, cooking times) and oven shelf levels to the recommendations in the following tables.



















With longer baking times, the oven can be switched off about 10 minutes before the end of baking time, to make use of the residual heat.

Unless otherwise stated, the values given in the tables assume that cooking is started with the oven cold.

Baking table

Baking on one oven level



Type of baking	Oven function	Oven level	Temperature °C	Time Hr: Mins.	
Baking in tins					
Ring cake or brioche		Convection with ring heating element	1	150-160	0:50-1:10
Madeira cake/fruit cakes		Convection with ring heating element	1	140-160	1:10-1:30
Sponge cake		Convection with ring heating element	1	140	0:25-0:40
Sponge cake		Conventional	1	160	0:25-0:40
Flan base - short pastry		Convection with ring heating element	3	170-180 ¹⁾	0:10-0:25
Flan base - sponge mixture		Convection with ring heating element	3	150-170	0:20-0:25
Apple pie		Conventional	1	170-190	0:50-1:00
Apple pie (2tins Ø20cm, diagonally off set)		Convection with ring heating element	1	160	1:10-1:30
Apple pie (2tins Ø20cm, diagonally off set)		Conventional	1	180	1:10-1:30
Savoury flan (e. g. quiche lorraine)		Convection with ring heating element	1	160-180	0:30-1:10
Cheesecake		Conventional	1	170-190	1:00-1:30
Cakes/pastries/breads on baking trays					
Plaited bread/bread crown		Conventional	3	170-190	0:30-0:40
Christmas stollen		Conventional	3	160-180 ¹⁾	0:40-1:00
Bread (rye bread) -first of all -then		Conventional	1	230 ¹⁾ 160-180	0:25 0:30-1:00
Cream puffs/eclairs		Conventional	3	160-170 ¹⁾	0:15-0:30
Swiss roll		Conventional	3	180-200 ¹⁾	0:10-0:20
Cake with crumble topping (dry)		Convection with ring heating element	3	150-160	0:20-0:40
Buttered almond cake/sugar cakes		Conventional	3	190-210 ¹⁾	0:15-0:30
Fruit flans (made with yeast dough/sponge mixture) ²⁾		Convection with ring heating element	3	150	0:35-0:50

Type of baking	Oven function	Oven level	Temperature °C	Time Hr: Mins.	
Fruit flans (made with yeast dough/sponge mixture) ²⁾		Conventional	3	170	0:35-0:50
Fruit flans made with short pastry		Convection with ring heating element	3	160-170	0:40-1:20
Yeast cakes with delicate toppings (e. g, quark, cream, custard)		Conventional	3	160-180 ¹⁾	0:40-1:20
Pizza (with a lot of topping) ²⁾		Convection with ring heating element	1	180-200 ¹⁾	0:30-1:00
Pizza (thin crust)		Convection with ring heating element	1	200-220 ¹⁾	0:10-0:25
Unleavened bread		Convection with ring heating element	1	200-220	0:08-0:15
Tarts (CH)		Convection with ring heating element	1	180-200	0:35-0:50
Biscuits					
Short pastry biscuits		Convection with ring heating element	3	150-160	0:06-0:20
Viennese whirls		Convection with ring heating element	3	140	0:20-0:30
Viennese whirls		Conventional	3	160 ¹⁾	0:20-0:30
Biscuits made with sponge mixture		Convection with ring heating element	3	150-160	0:15-0:20
Pastries made with egg white, meringues		Convection with ring heating element	3	80-100	2:00-2:30
Macaroons		Convection with ring heating element	3	100-120	0:30-0:60
Biscuits made with yeast dough		Convection with ring heating element	3	150-160	0:20-0:40
Puff pastries		Convection with ring heating element	3	170-180 ¹⁾	0:20-0:30
Rolls		Convection with ring heating element	3	160 ¹⁾	0:20-0:35
Rolls		Conventional	3	180 ¹⁾	0:20-0:35
Small cakes (20per tray)		Convection with ring heating element	3	140 ¹⁾	0:20-0:30
Small cakes (20per tray)		Conventional	3	170 ¹⁾	0:20-0:30

1) Pre-heat the oven

2) Use the drip tray or roasting tray

Baking on more than one oven level

Type of baking	Convection with ring heating element 	Convection with ring heating element 	Temperature in °C	Time Hours: Mins.
	Shelf positions from bottom			
	2 levels	3 levels		
Cakes/pastries/breads on baking trays				
Cream puffs/Eclairs	1 / 4	---	160-180 ¹⁾)	0:35-0:60
Dry streusel cake	1 / 3	---	140-160	0:30-0:60
Biscuits/small cakes/pastries/rolls				
Short pastry biscuits	1 / 3	1 / 3 / 5	150-160	0:15-0:35
Viennese whirls	1 / 3	1 / 3 / 5	140	0:20-0:60
Biscuits made with sponge mixture	1 / 3	---	160-170	0:25-0:40
Biscuits made with egg white, meringues	1 / 3	---	80-100	2:10-2:50
Macaroons	1 / 3	---	100-120	0:40-1:20
Biscuits made with yeast dough	1 / 3	---	160-170	0:30-0:60
Puff pastries	1 / 3	---	170-180 ¹⁾	0:30-0:50
Rolls	1 / 4	---	160	0:30-0:55
Small cakes (20 per tray)	1 / 4	---	140 ¹⁾	0:25-0:40

1) Pre-heat the oven

Tips on baking

Baking results	Possible cause	Remedy
The cake is not browned enough at the bottom	Wrong oven level	Place cake lower in the oven
The cake sinks (becomes soggy, lumpy, streaky)	Oven temperature too high	Use a slightly lower setting
	Baking time too short	Set a longer baking time Baking times cannot be reduced by setting higher temperatures
	Too much liquid in the mixture	Use less liquid Pay attention to mixing times, especially if using mixing machines
Cake is too dry	Oven temperature too low	Set oven temperature higher
	Baking time too long	Set a shorter baking time
Cake browns unevenly	Oven temperature too high and baking time too short	Set a lower oven temperature and a longer baking time
	Mixture is unevenly distributed	Spread the mixture evenly on the baking tray
Cake is not done within the baking time given	Temperature too low	Use a slightly higher oven setting

Table: Desserts

Desserts	Convection with ring heating element 		Time
	Shelf position	Temperature °C	Hr. : Min.
Apple pie	3	180-190	0:45-0:50
Rice pudding	3	130-140	2:00-2:30
Fruit crumble	3	160	0:50-1:10
Pineapple upside down cake	3	160	0:35-0:45
Pavlova	3	130	1:00-1:10
Baked custard	3	150-160	0:45-1:00
Baked apples	3	160-170	0:40-1:00
Bread and butter pudding	3	170-180	0:40-0:55
Apple charlotte	3	180-190	0:40-0:55
Soufflé - sweet/savoury	3	170-190 ¹⁾	0:30-0:45







1) Pre-heat oven

Pizza setting table

Type of baking	Shelf position	Temperature °C	Time Hr: Mins.
Pizza (thin crust)	I	180 - 200 ¹⁾	20 - 30
Pizza (with a lot of topping)	I	180 - 200	20 - 30
Tarts	I	180 - 200	45 - 60
Spinach flan	I	160 - 180	45 - 60
Quiche Lorraine	I	170 - 190	40 - 50
Quark flan, round	I	140 - 160	60 - 90
Quark flan on tray	I	140 - 160	50 - 60
Apple cake, covered	I	150 - 170	50 - 70
Vegetable pie	I	160 - 180	50 - 60
Unleavened bread	I	250 - 270 ¹⁾	10 - 20
Puff pastry flan	I	160 - 180 ¹⁾	40 - 50
Flammekuchen (Pizza-like dish from Alsace)	I	250 - 270 ¹⁾	12 - 20
Piroggen (Russian version of calzone)	I	180 - 200 ¹⁾	15 - 25





1) Pre-heat the oven

Bakes and gratins table

Dish	Oven function	Shelf position	Temperature °C	Time Hours mins.
Pasta bake	 Conventional	I	180-200	0:45-1:00
Lasagne	 Conventional	I	180-200	0:25-0:40
Vegetables au gratin ¹⁾	 Rotitherm	I	160-170	0:15-0:30
Baguettes topped with melted cheese ¹⁾	 Rotitherm	I	160-170	0:15-0:30
Sweet bakes	 Conventional	I	180-200	0:40-0:60
Fish bakes	 Conventional	I	180-200	0:30-1:00
Stuffed vegetables	 Rotitherm	I	160-170	0:30-1:00

1) Pre-heat the oven

Frozen ready meals table

Food to be cooked	Oven function	Shelf position	Temperature °C	Time
Frozen pizza	 Conventional	3	as per manufacturer's instructions	as per manufacturer's instructions
Chips ¹⁾ (300-600 g)	 Rotitherm	3	200-220	as per manufacturer's instructions
Baguettes	 Conventional	3	as per manufacturer's instructions	as per manufacturer's instructions
Fruit flans	 Conventional	3	as per manufacturer's instructions	as per manufacturer's instructions

1) Comments: Turn chips 2 or 3 times during cooking

Roasting

Oven function: Convection with ring heating element , **Conventional**  or **Rotitherm** .

Roasting dishes

- Any heat-resistant ovenware is suitable to use for roasting (please read the manufacturer's instructions).
- Large roasting joints can be roasted **directly in the roasting tray or on the oven shelf with the roasting tray placed below it.**
- For all lean meats, we recommend **roasting these in a roasting tin with a lid.** This will keep the meat more succulent.
- All types of meat, that can be browned or have crackling, can be roasted in the **roasting tin without the lid.**











Tips on using the roasting chart

The information given in the following table is for guidance only.

















- We recommend cooking meat and fish **weighing 1 kg and above in the oven.**
- To prevent escaping meat juices or fat from burning on to the pan, we recommend placing some liquid in the roasting pan.
- If required, turn the roast (after 1/2 - 2/3 of the cooking time).
- Baste large roasts and poultry with their juices several times during roasting. This will give better roasting results.
- You can switch the oven off about 10 minutes before the end of the roasting time, in order to utilise the residual heat.

Table: Meat, roasting, casseroles

Meat	Oven functions	Shelf position	Temperature °C	Time Hr. : Min.	
Pork					
Shoulder; leg; rolled; boned spare rib; loin of pork		Rotitherm	I	170-180	0:30-0:35 per 450 g/l lb plus 30-35 mins
Beef					
Inexpensive cuts		Rotitherm	I	160-170	0:35-0:40 per 450 g/l lb plus 15-20 mins
Prime cuts					
-rare		Rotitherm	I	150-160 ¹⁾	0:15-0:20 per 450 g/l lb plus 15-20 mins
-medium		Rotitherm	I	150-160	0:20-0:25 per 450 g/l lb plus 25-25 mins
-well done		Rotitherm	I	150-160	0:30-0:35 per 450 g/l lb plus 25-30 mins
Yorkshire pudding					
- small		Convection with ring heating element	3	200 ¹⁾	0:10-0:15
- large		Convection with ring heating element	I	180 -190 ¹⁾	0:30-0:40
Lamb		Rotitherm	I	150-160	0:30-0:35 per 450 g/l lb plus 30-35 mins
Veal		Rotitherm	I	170-180	0:30-0:35 per 450 g/l lb plus 30-35 mins

1) Pre-heat oven

Table: Roasting, casseroles, au gratin

Poultry, Game, Fish, Vegetables	Quantity approx.	Oven function	Shelf position	Temperature °C	Time Hr. : Min.	
Casseroles, miscellaneous						
Casseroles	1 kg/2 lbs		Convection with ring heating element	1	150	2:30-3:00
	1 kg/2 lbs		Conventional	1	160-170	
Lancashire Hot Pot	1 kg/2 lbs		Conventional	1	180-190	2:15-2:30
Moussaka	1 kg/2 lbs		Convection with ring heating element	1	170-180	0:40-0:50
Meat Loaf	675 g/1.5 lbs		Rotitherm	1	160-170	1:00-1:10
Poultry / Game						
Chicken	1 kg/2 lbs		Rotitherm	3	190-210	0:50-1:10
Chicken	1.5 kg/3 lbs		Rotitherm	1	190-210	1:15-1:30
Duck	1.5-2 kg/ 3.5-4 lbs		Rotitherm	1	180-200	1:15-1:45
Goose	3.5-5 kg/ 8-10 lbs		Rotitherm	1	160-180	2:30-3:30
Turkey	2.5-3.5 kg/ 5-7 lbs		Rotitherm	1	160-180	1:45-2:30
Turkey	4-6 kg/ 8-13 lbs		Rotitherm	1	140-160	2:30-4:00
Pheasant, Wild Duck, Rabbit	1 kg/2 lbs		Conventional	3	210-220	0:30-1:00
Partridge/Pigeon	per 300-500g		Rotitherm	3	200-220	0:30-0:50
Fish (baked, steamed)						
Whole fish	1-1.5 kg/ 2-3 lbs		Conventional	1	210-220	0:45-1:15
Fish pies, bakes	750 g-1 kg/ 1.5-2 lbs		Rotitherm	3	180-200	0:30-1:00
Vegetables						
Stuffed pepper/ aubergines	---		Convection with ring heating element	1	180-190	0:30-1:00
Au gratin dishes	---		Rotitherm	3	180-190	0:15-0:45

Low temperature cooking

Oven function: Low temperature cooking

With the oven function Low temperature cooking  meat becomes beautifully tender and remains particularly succulent.



We recommend Low temperature cooking for pieces of tender, lean meat and fish.

Low temperature cooking is not suitable for e. g. pot roasts or fatty pork roasts.

The oven heats up to the selected or pre-set temperature. When this temperature is reached, an acoustic signal sounds. After 10 minutes the oven switches to a lower temperature to continue cooking.

We recommend 120°C for smaller pieces of meat, e. g. steaks

150°C is recommended for larger pieces of meat, e. g. fillet of beef.

 When using the oven function Low temperature cooking  always cook dishes uncovered **without a cover**.

1. Sear the meat in a pan over a very high heat.
2. Place meat in a roasting dish or directly on the oven shelf with a tray underneath to catch the fat.
3. Place in the oven. Select oven function Low temperature cooking  change the temperature, if necessary, and cook until done. (See table.)





 The oven function **Low temperature cooking**  **is not possible together with the clock functions Cooking duration**  **and End of cooking** 

Table: Low temperature cooking

Food to be cooked	Weight g	Setting	Shelf position	Total time mins.
Roast beef	1000-1500	150°C	1	90-110
Fillet of beef	1000-1500	150°C	3	90-110
Roast veal	1000-1500	150°C	1	100-120
Steaks	200 - 300	120°C	3	20-30

Grill sizes

Oven function: Grill  or Dual grill 
with maximum temperature setting



Important: Always grill with the oven door closed.



The empty oven should **always be pre-heated with the grill functions for 5 minutes.**



- For grilling, place the **shelf** in the **recommended shelf position.**
- Always insert the **tray for collecting the fat** into the **first shelf position** from the bottom.
- The grilling times are guidelines.
- Grilling is particularly suitable for flat pieces of meat or fish.

Grilling table

Food to be grilled	Oven level	Grilling time	
		1st side	2nd side
Burgers	4	8-10 mins.	6-8 mins.
Pork fillet	4	10-12 mins.	6-10 mins.
Sausages	4	8-10 mins.	6-8 mins.
Fillet steaks, veal steaks	4	6-7 mins.	5-6 mins.
Fillet of beef, roast beef (approx. 1 kg)	3	10-12 mins.	10-12 mins.
Toast ¹⁾	3	4-6 mins.	3-5 mins.
Toast with topping	3	6-8 mins.	---

1) Do not pre-heat

Defrosting

Oven function: Defrost   (no temperature setting)

- Unwrap the food and place it on a plate on the oven shelf.
- Do not cover with a plate or bowl, as these can substantially lengthen the defrosting time.
- For defrosting, place the shelf in the **1st oven level from the bottom**.

Defrosting table

Dish	Defrosting time mins.	Further defrosting time (mins.)	Comments
Chicken, 1000 g	100-140	20-30	Place the chicken on an upturned saucer placed on a large plate Turn halfway through
Meat, 1000 g	100-140	20-30	Turn halfway through
Meat, 500 g	90-120	20-30	Turn halfway through
Trout, 150g	25-35	10-15	---
Strawberries, 300g	30-40	10-20	---
Butter, 250g	30-40	10-15	---
Cream, 2 x 200g	80-100	10-15	Cream can also be whipped when still slightly frozen in places
Gateau, 1400g	60	60	---

Drying

Oven function: Convection with ring heating element

- Use oven shelves covered with greaseproof paper or baking parchment.
- You get a better result if you switch the oven off halfway through the drying time, open the door and leave the oven to cool down overnight.
- After this, finish drying the food to be dried.

Food to be dried	Temperature in °C	Oven level		Time in hours (Guideline)
		1 level	2 levels	
Vegetables				
Beans	60-70	3	1 / 4	6-8
Peppers (strips)	60-70	3	1 / 4	5-6
Vegetables for soup	60-70	3	1 / 4	5-6
Mushrooms	50-60	3	1 / 4	6-8
Herbs	40-50	3	1 / 4	2-3
Fruit				
Plums	60-70	3	1 / 4	8-10
Apricots	60-70	3	1 / 4	8-10
Apple slices	60-70	3	1 / 4	6-8
Pears	60-70	3	1 / 4	6-9

Keep warm

For keeping food warm.

The temperature regulates itself automatically to 80 °C.

Oven level: 3

also see section - Operating the oven - under other functions Heat+Hold.

Making preserves

Oven function: Bottom heat

- For preserving, use only commercially available preserve jars of the same size.
- **Jars with twist-off or bayonet type lids and metal tins are not suitable.**
- When making preserves, the **first shelf position from the bottom** is the one most used.
- Use the shelf for making preserves. There is enough room on this for up to six 1-litre preserving jars.
- The jars should all be filled to the same level and clamped shut.
- Place the jars on the baking tray in such a way that they are not touching each other.
- Pour approx. 1/2 litre of water into the baking tray so that sufficient moisture is produced in the oven.
- As soon as the liquid starts to pearl in the first jars (after about 35-60 minutes with 1 litre jars), switch the oven off or reduce the temperature to 100°C (see table).

Preserves table

The times and temperatures for making preserves are for guidance only

Preserve	Temperature in °C	Cooking time until simmering in mins.	Continue to cook at 100°C in mins.
Soft fruit			
Strawberries, blueberries, raspberries, ripe gooseberries	150-160	35-45	---
Unripe gooseberries	150-160	35-45	10-15
Stone fruit			
Pears, quinces, plums	150-160	35-45	10-15
Vegetables			
Carrots ¹⁾	150-160	50-60	5-10
Mushrooms ¹⁾	150-160	40-60	10-15
Cucumbers	150-160	50-60	---
Mixed pickles	150-160	50-60	15
Kohlrabi, peas, asparagus	150-160	50-60	15-20
Beans	150-160	50-60	---

1) Leave standing in oven when switched off

Cleaning and care



Warning: First switch off the appliance and let it cool down before carrying out any cleaning.

Warning: For safety reasons, do **not** clean the appliance with steam blasters or high-pressure cleaners.

Attention: Do not use any corrosive cleaning fluids, sharp objects or stain removers.

Do not clean the glass oven door with abrasive fluids or metal scrapers, which could scratch the surface. The glass could crack and shatter.

Outside of the appliance

- Wipe the front of the appliance with a soft cloth and a solution of hot water and washing up liquid.
- For metal fronts, use normal commercially available cleaning agents.
- Please do not use scouring agents and abrasive sponges.

Oven interior



Warning: For the purpose of cleaning the oven must be switched off and have cooled down.



Clean the appliance after each use. In this way, residue is easier to clean off and does not have the chance to burn on. Residue that is not removed may cause changes to the surface colour when Pyroluxe is used.

1. The oven light switches on automatically when the oven door is opened.
2. After every use, wipe the oven with a solution of washing-up liquid and allow to dry.



In the event of stubborn dirt, clean using Pyroluxe.





Important: If you are using an oven spray, be sure to follow the manufacturer's instructions.

Accessories

Wash all slide-in units (shelf unit, baking tray, shelf support rails etc.) after each use and dry well. Soak briefly to make them easier to clean.

Pyrolytic cleaning

 **Warning:** During this process the oven gets extremely hot. Keep children away.

 **Important** Before carrying out the Pyroluxe process, all removable parts, including the side rails, must be removed from the oven.

 If you use the **oven shelf runners** that are available as special accessories, these must be **removed before pyrolytic cleaning**.

If the side rails or oven shelf runners are still in place, 'C1' appears in the clock display.



The pyrolytic cleaning process then cannot be started due to a safety cut-out that protects the side rails/oven shelf runners.

If 'C3' appears in the clock display, pyrolytic cleaning does not start. Close the oven door properly.

Pyrolytic cleaning



1. First remove the worst of the residue manually.
2. Select oven function Pyroluxe .
 - P2 appears in the temperature display.
 - "2:45" appears in the clock display
 - Cook time flashes for approx. 5 secondsPyrolytic cleaning then starts.

 Do not open the oven door during the heating up time, or the process is cancelled.

 The Light does not work. When a pre-set temperature is reached, the oven door is locked. The symbol  is displayed and the bars of the heat indicator are lit until the door is unlocked again.

 If the process is interrupted while the door is locked, only pyrolytic cleaning can be selected as the next function. This only applies while the oven door is locked.



Changing the length of time

1. Proceed as described in the section "Pyrolytic cleaning".
2. As long as Cooking duration  is flashing, select the desired length for the process using  or :

- 2:15 for a light degree of soiling,
- 2:45 for a normal degree of soiling,
- 3:15 for a high degree of soiling.

Cooking duration  flashes for approx. 5 seconds.

Pyrolytic cleaning then starts.

 If Cooking duration  is no longer flashing, press the Time functions button again and then perform the setting procedure.

3. When the pyrolytic cleaning is completed, press any button to end.

Changing the switch-off time for the pyrolytic cleaning

The switch-off time can be delayed using the clock function End of cooking  (within 2 minutes of the pyrolytic cleaning starting).

Oven shelf runner

The shelf support rails on the left and right hand sides of the oven can be removed for cleaning the side walls.

Removing the shelf support rails

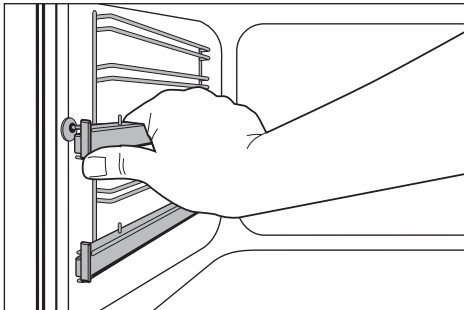

First pull the front of the rail away from the oven wall and then unhitch at the back.

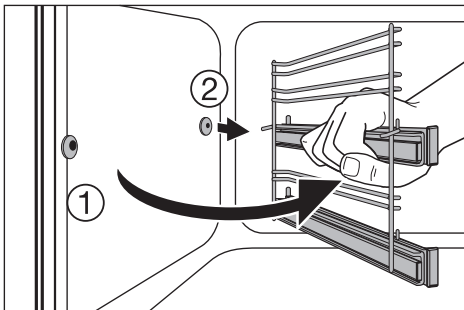

Fitting the shelf support rails

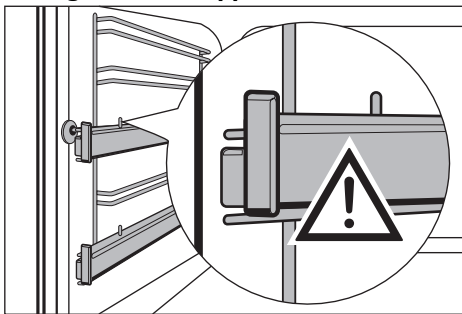

⚠ When inserting the rails, make sure that the retaining pins on the telescopic runners are pointing to the front.

To install, first reattach the rails at the back, then put them into position at the front and press them into place.

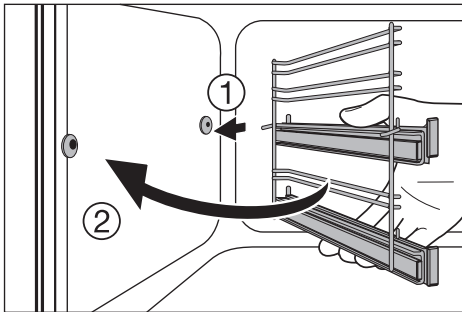

Cleaning the oven shelf runner

Clean oven shelf runners with hot water and washing up liquid.



Important: The oven shelf runners **cannot be cleaned in the dishwasher.**



Important: Never grease the telescopic runners.



Information regarding use in appliances with pyrolytic cleaning:
The oven shelf runners must be removed before pyrolytic cleaning is carried out.

Oven lighting



Warning: There is a danger of electric shock! Prior to changing the oven light bulb:

- Switch off the oven!
- Remove the fuses in the fuse box or switch off the circuit breaker.



Place a cloth on the oven floor to protect the oven light and glass cover.

Replacing the oven light bulb/cleaning the glass cover

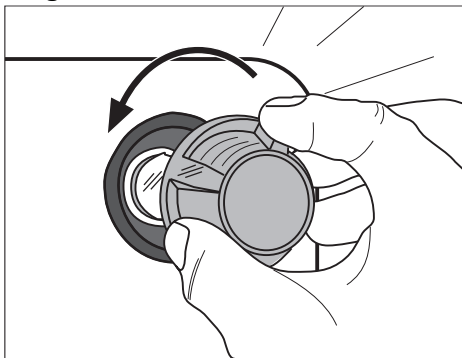

1. Remove the glass cover by turning it anti-clockwise and then clean it.
2. If necessary:
Replace bulb with a 40 watt, 230 V, 300 °C heat-resistant oven light bulb.
3. Refit the glass cover.

Oven door

For easier cleaning of the oven interior the oven door of your appliance can be taken off its hinges.

Removing the oven door from its hinges

1. Open the oven door as far as it will go.

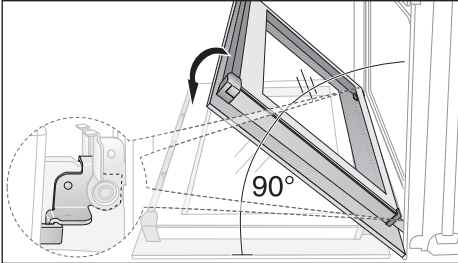

2. Undo the **clamping levers (A)** on both door hinges **fully**.

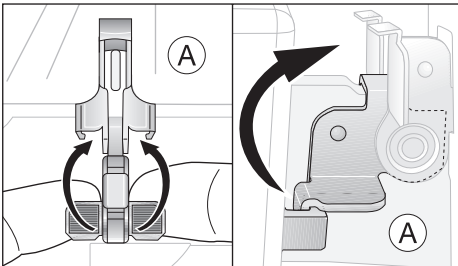

3. Close the oven door as far as the first position (approx. 45°).

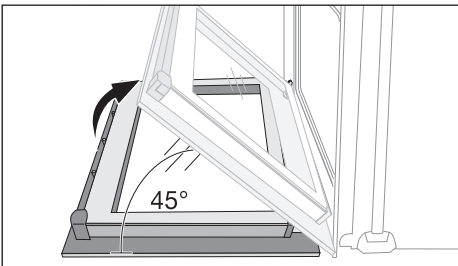

4. Take hold of the oven door with a hand on each side and pull it away from the oven at an upwards angle (**Take care: It is heavy**).

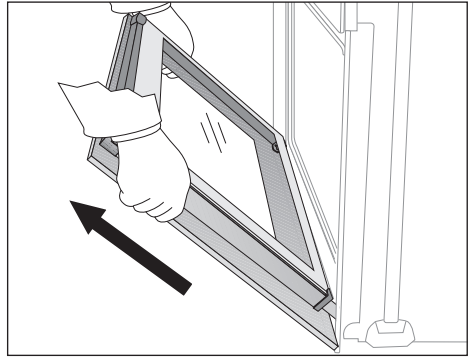

i Lay the oven door with the outer side facing downwards on something soft and level, for example, a blanket in order to prevent scratches.

Hang the oven door back on its hinges

1. From the handle side take hold of the oven door with a hand on each side and hold at an angle of approx. 45° .
Position the recesses on the bottom of the oven door on the hinges on the oven.
Let the door slide down as far as it will go.

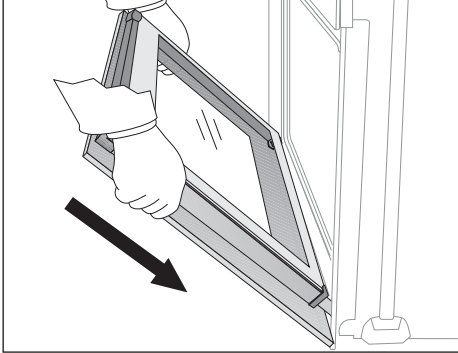

2. Open the oven door as far as it will go.

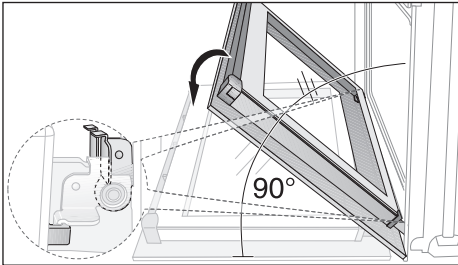

3. Fold up the clamping levers (A) on both door hinges back into their original positions.

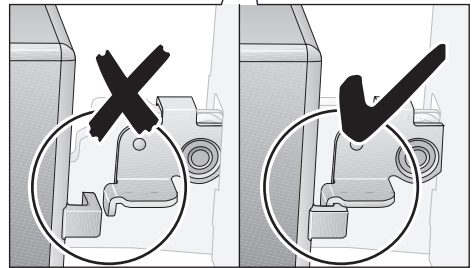
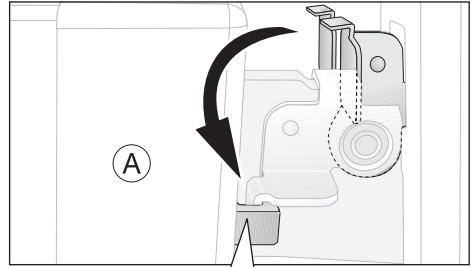

4. Close the oven door.

Oven door glass

The oven door is fitted with four panels of glass mounted one behind the other. The inner panels can be removed for cleaning.

 **Important** Rough handling, especially around the edges of the front panel, can cause the glass to break.

Removing door glass panels

1. Open the oven door as far as it will go.

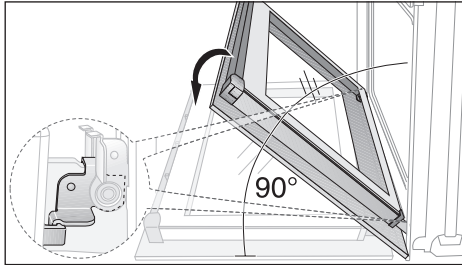

2. Undo the **clamping levers (A)** on both door hinges **fully**.

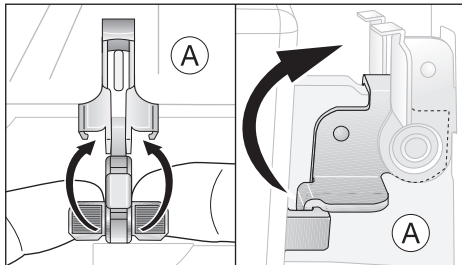

3. Close the oven door as far as the first position (approx. 45°).

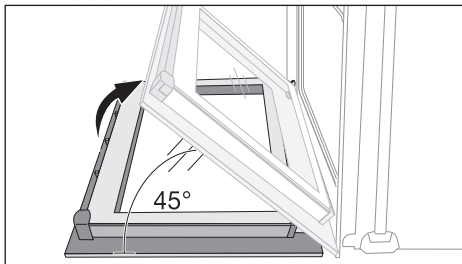

4. Take hold of the door trim (B) on the upper edge of the door at both sides and press inwards to release the clip seal. Then remove the door trim by pulling it upwards.

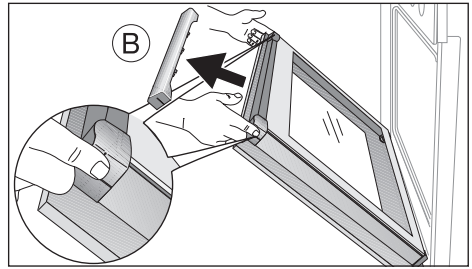

5. Take hold of the door glass panels on their upper edge one after the other and take them out of the guide by pulling them upwards.

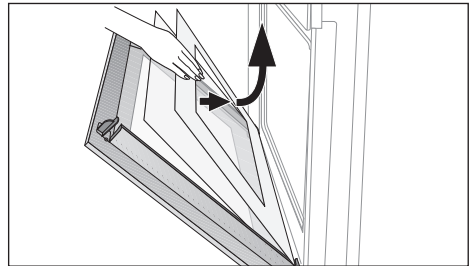

Cleaning the door glass panels

Clean the door glass panels thoroughly with a solution of water and washing up liquid. Then dry them carefully.

Putting the door glass panels back.

1. From above insert the door glass panels one after the other into the door profile at the bottom edge of the door at an angle and lower them.

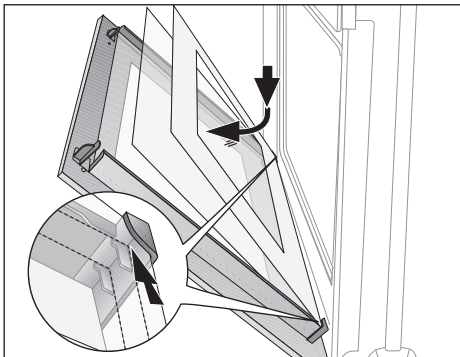

i The two smaller panels first, then the larger panel.

2. Take hold of the door trim (B) at each side, position it on the inside edge of the door and plug the door trim (B) into the upper edge of the door.

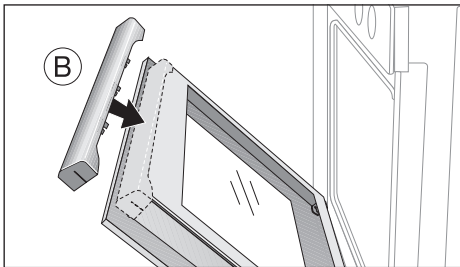

i On the open side of the door trim (B) there is a guide bar (C). This must be pushed **between** the outer door panel and the guide corner (D).
The clip seal (E) must be snapped in.

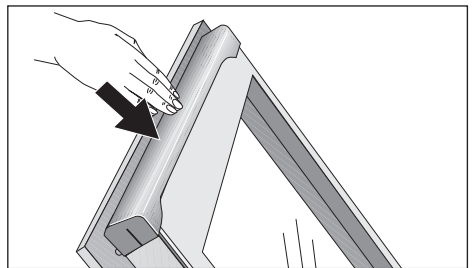
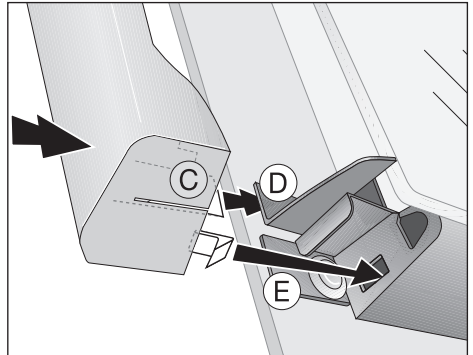

The clip seal (E) must be snapped in.
3. Open the oven door as far as it will go.

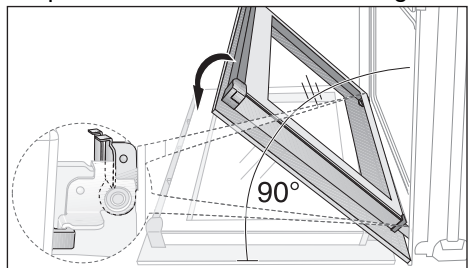

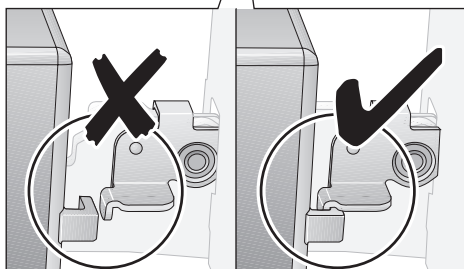
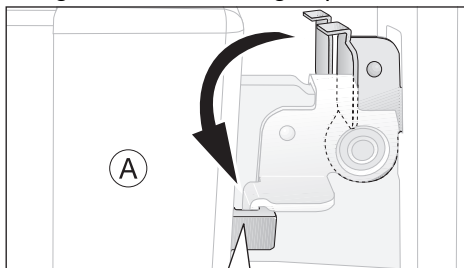

4. Fold up the clamping levers (A) on both door hinges back into their original positions.



5. Close the oven door.

What to do if ...

Problem	Possible cause	Remedy
The oven does not heat up	The oven is not switched on	Switch the oven on
	The clock is not set	Set the current time on the clock
	The required settings have not been set	Check the settings
	The oven's automatic cut-out has been triggered.	See Automatic cut-out
	The fuse in the house's electrical wiring (fuse box) has been tripped	Check fuse. If the fuses trip repeatedly, please call an authorised electrician
The oven lighting is not operating	The oven bulb is faulty	Change the oven bulb
The oven is not heating up. Time  is lit.	Demo mode is on.	Keep Time functions button pressed for 2 seconds, then within 2 seconds press and hold Time functions and  buttons for 2 seconds
The pyrolysis function is not working ("C1" is shown in the time display)	Side rails/oven shelf runners have not been removed	Remove side rails/oven shelf runners
The pyrolysis function is not working ("C3" is shown in the time display)	Door not properly closed or door lock defective	Close door properly
F2 appears in the clock display	Door not properly closed or door lock defective	Close door properly; Turn the appliance off and on again via the house fuse or the safety switch in the fuse box; If displayed again, please contact the Customer Care Department
An error code not listed above appears in the time display	Fault in the electronics	Switch off the appliance via the house fuse or the safety switch in the fuse box and switch it on again If displayed again, please contact your local Service Force Centre

If you are unable to remedy the problem by following the above suggestions, please contact our extended warranty administrators on 0870 010 7887 who will give you details of your local repair agent.



Warning! Repairs to the appliance are only to be carried out by qualified service engineers. Considerable danger to the user may result from improper repairs.



If you call an engineer to a fault listed in the table, or to repair a fault caused by incorrect use or installation, a charge will be made even if the appliance is under guarantee.



Advice on cookers with metal fronts:

Because of the cold surface at the front of the cooker, opening the oven door during (or just after) baking or roasting may cause the glass to steam up.

Electrical connection

The oven is designed to be connected to 230-240V~(50Hz) electricity supply.

The oven has an easily accessible terminal block which is marked as follows:

- Letter L - Live terminal
- Letter N - Neutral terminal
-  - Earth terminal



This oven must be earthed!

The cable used to connect the oven to the electrical supply must comply to the specifications given below.

For UK use only

Connection via	Min. size Cable/ flex	Cable/flex type	Fuse
Cooker Control Circuit	2,5 mm ²	PVC/PVC twin and earth	min: 15A max: 20A

It is necessary that you install a double pole switch between the oven and the electricity supply (mains), with a minimum gap of 3mm between the switch contacts and of a type suitable for the required load in compliance with the current regulations.

The switch must not break the yellow and green earth cable at any point.

Important

After installation and connecting, the cable must be placed so that it cannot at any point reach a temperature of more than 50°C above the ambient temperature.

Before the oven is connected, check that the main fuse and the domestic installation can support the load; and that the power supply is properly earthed.

The manufacturer declines any responsibility should these safety measures not be carried out.

Installation instructions



Attention: The appliance must be installed according to the instructions. The installation must be undertaken by a qualified engineer according to the relevant British Standards. Any damage resulting from improper repairs is not covered by the warranty.



Safety information for the installer

- The electrical installation is to be set up so that the appliance can be isolated from the mains with a minimum 3mm all-pole contact separation. Suitable separation devices include e.g. cut-outs, fuses (screw fuses are to be taken out of the holder), RCD's and contactors.
- Anti-shock protection must be provided by the installation.
- The built-in unit must meet the stability requirements of DIN 68930.
- Built-in ovens and built-in cooking surfaces are fitted with special connection systems. For safety reasons, they must only be combined with appliances from the same manufacturer.

The use of thermal insulation bars is not permitted in cookers and ovens with Pyroluxe, if the recess has a back wall and a solid bottom to the compartment.

However if the bottom is shortened by at least 20 mm and there is ventilation in the plinth of the same diameter, it is possible to build them in.

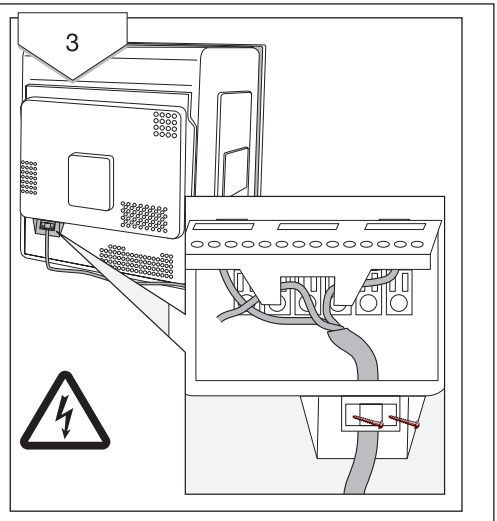
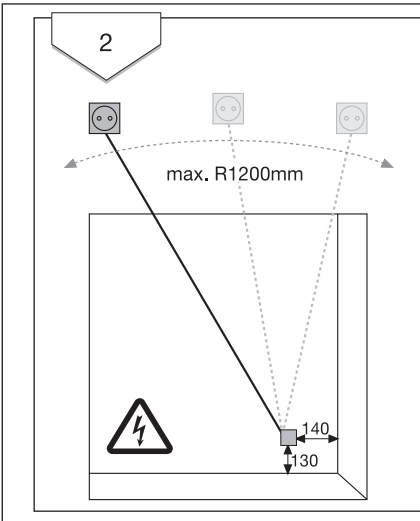
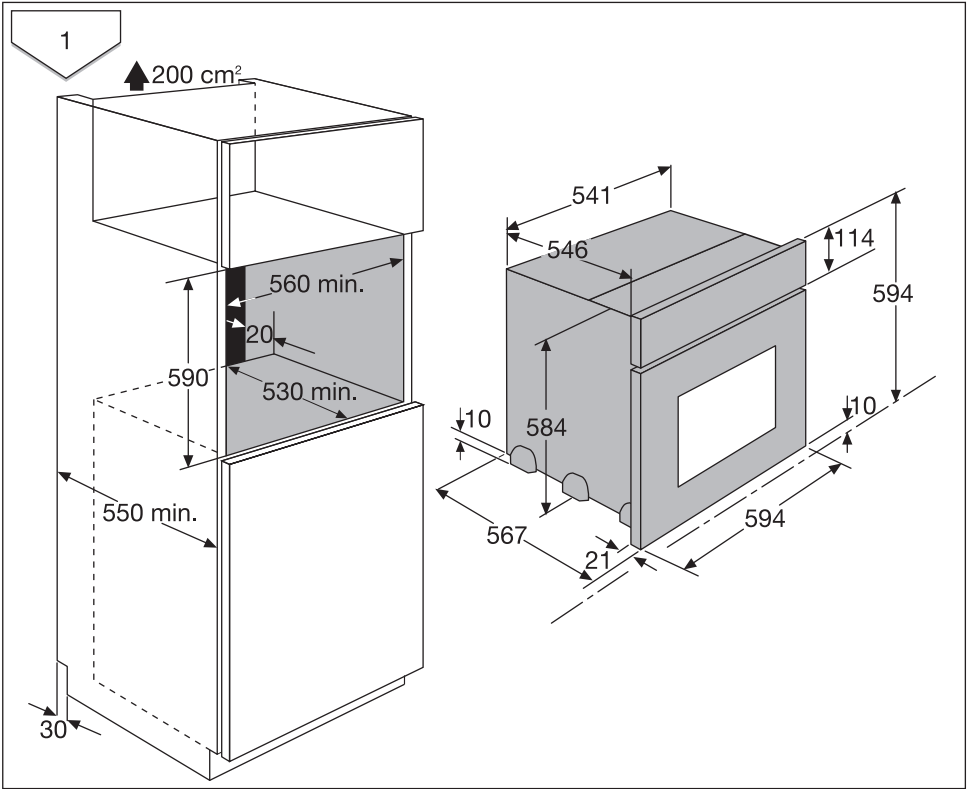

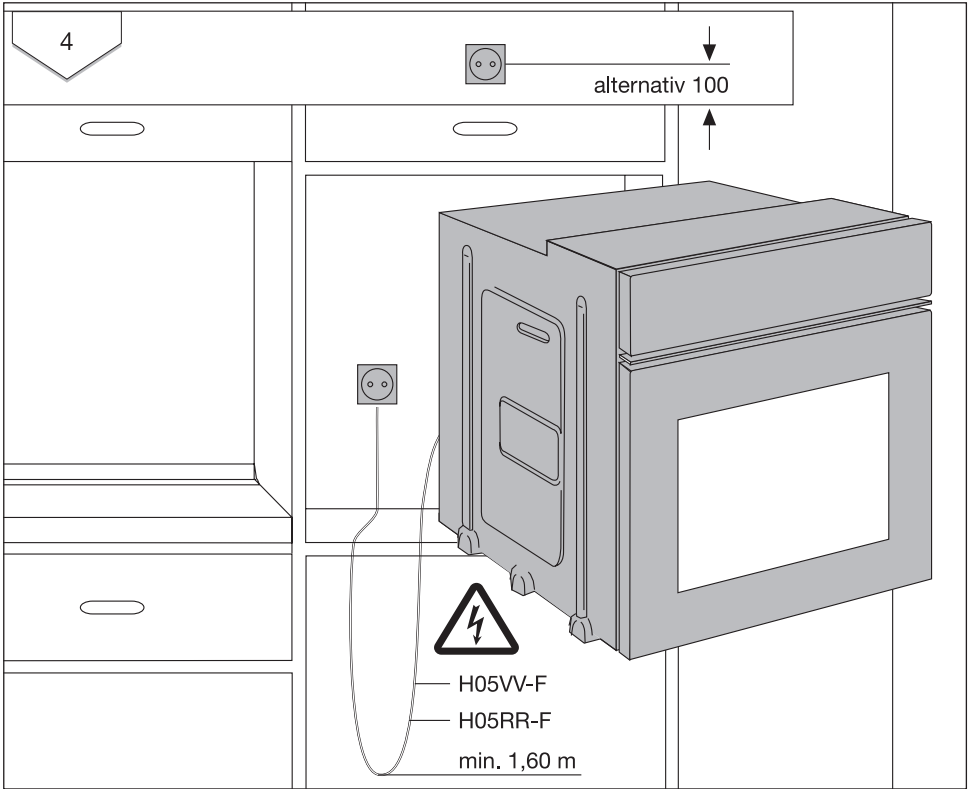

5

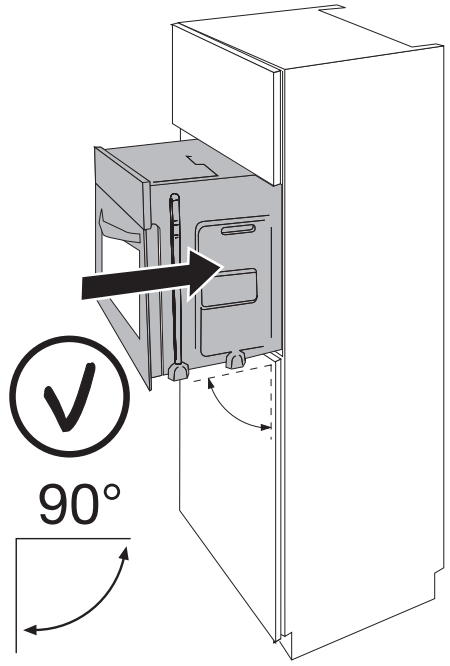
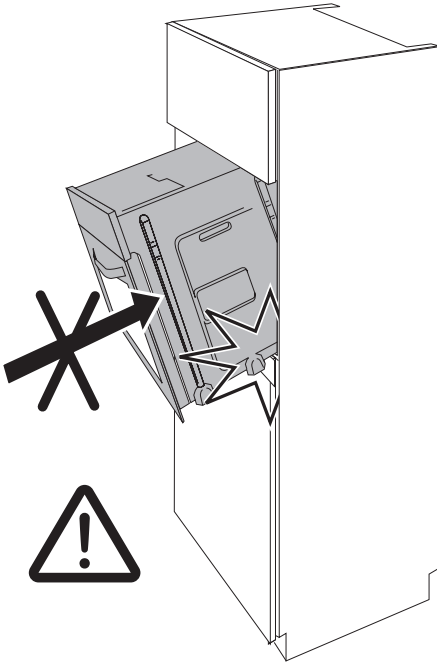

6

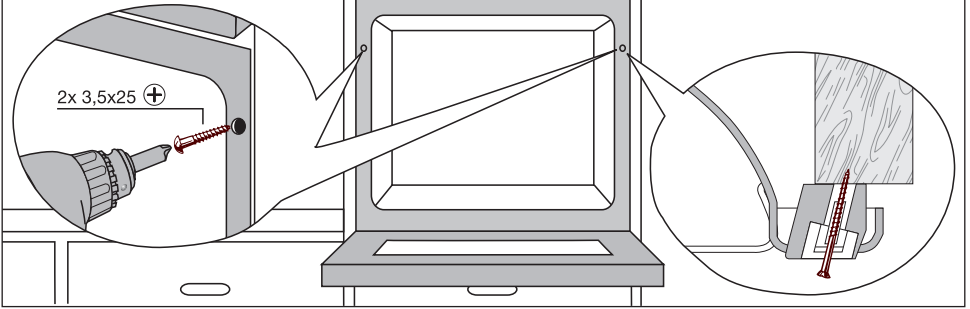

Repairs - after sales service

If your appliance is not performing satisfactorily; consult the fault finding guide within this instruction book (Something not working). In the event of a fault occurring which you cannot resolve yourself from advice given within this instruction manual your first step is to contact our extended warranty administrators on **0870 0107887** who will give you details for your local Service Force.

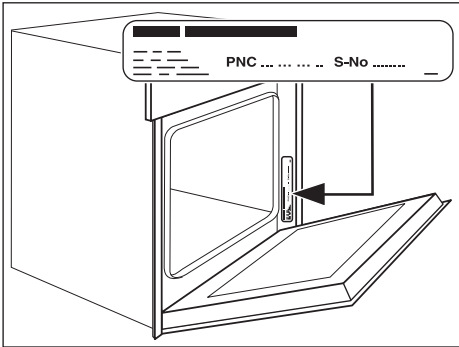

When contacting Service Force, please quote the model (Mod.) and serial number (S.N.), both of which are shown on the rating plate located on the front frame of the appliance. So that you always have these numbers at hand, we recommend you to make a note of them here:

Mod.:

PNC:

S.N.:

Your appliance is covered by a 3 year parts and labour guarantee (see separate details given at point of sale). Please retain your purchase receipt safely for the service engineer to verify the purchase details.

Spare parts

This product should be serviced by any authorised service engineer; and only genuine spare parts should be used.

Under no circumstances should you attempt to repair the appliance yourself.

Repairs carried out by inexperienced persons may cause injury or serious malfunctioning.

Contact our extended warranty administrators on **0870 0107887** who will give you details for your Service Force repair agent.

Always insist on genuine spare parts.

John Lewis Partnership

171 Victoria Street
London SW1E 5NN
www.johnlewis.com

